

Specification Sheets for ICON 2436 Wall Mirror

SPECIFICATION VARIANCES

Dimensions on finished mirrors may vary slightly from those shown on these specification sheets due to variability in construction materials.

Our products are engineered to maintain close dimensional tolerances but variability in manufacturing materials can change dimensions slightly (normally within $\pm 1/8"$ but occasionally up to $\pm 3/16"$).

In most applications these slight variations will have no impact upon installation, appearance or function. However, when planning and finishing a space for a built in mirror, **do not frame or finish the space before measuring the actual mirror!**

We can not be responsible for any expenses incurred as a result of the end user or contractor not following this guideline.

REV: 2021-05

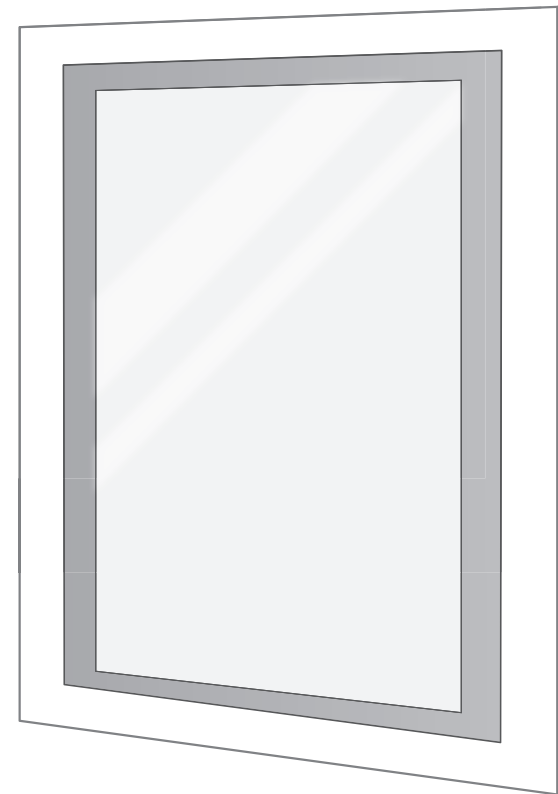

STRASSER

Features

- Dimmable LED task lighting
- Integrated touch sensor control with memory
- Energy efficient LED lighting 6000K
- 3720 Lumens
- CRI 90+
- Integrated Defogger

Construction

- Quality polished edge mirror
- Single phase wire installation, silver backed, copper free
- Construction for surface mounting
- Includes installation hardware

Codes/Standards Applicable

- Conforms to UL Std. 962
- Cert. to CSA Std. C22.2 No.250.0-08
- ETL Intertek 5004931

Electrical System

- 120Vac, 60Hz, 50.6W
- Electric Current: 0.46A
- Wattage: 50.6W

Model

- ICON 2436

Dimensions

- Height: 24"
- Width: 36"
- Depth: 1-9/16"

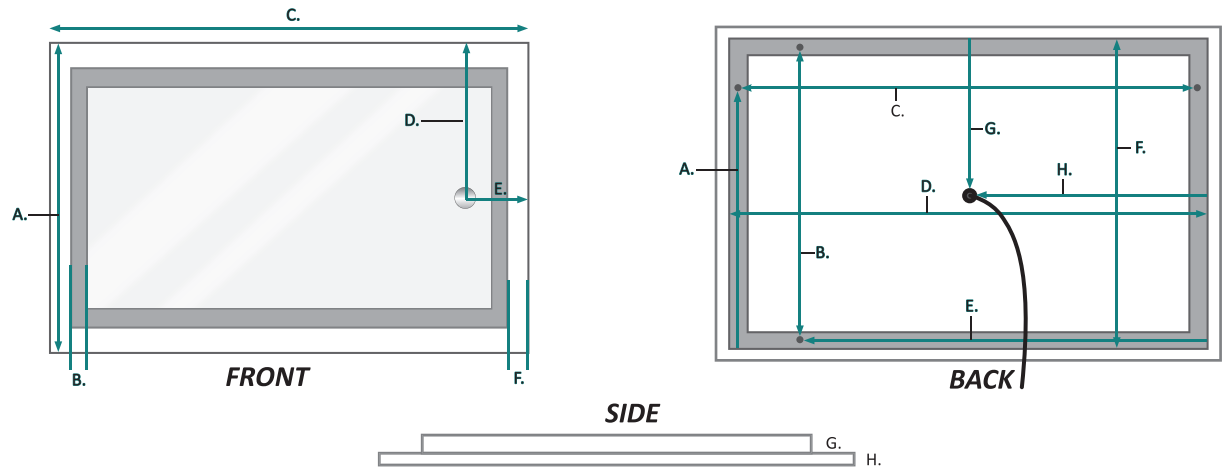

FRONT & SIDE

MODEL	A	B	C	D	E	F	G	H
ICON2436	24	1-1/8	36	12	5	1-5/8	1-3/8	3/16

BACK

MODEL	A	B	C	D	E	F	G	H
ICON2436	22-3/8	23-1/4	34-1/4	35-3/8	31	19-1/4	9-5/8	17-7/8