

Specification Sheets for SVANGE 3636L Medicine Cabinet

SPECIFICATION VARIANCES

Dimensions on finished mirrors may vary slightly from those shown on these specification sheets due to variability in construction materials.

Our products are engineered to maintain close dimensional tolerances but variability in manufacturing materials can change dimensions slightly (normally within $\pm 1/8"$ but occasionally up to $\pm 3/16"$).

In most applications these slight variations will have no impact upon installation, appearance or function. However, when planning and finishing a space for a built in mirror, **do not frame or finish the space before measuring the actual mirror!**

We can not be responsible for any expenses incurred as a result of the end user or contractor not following this guideline.

REV: 2021-11

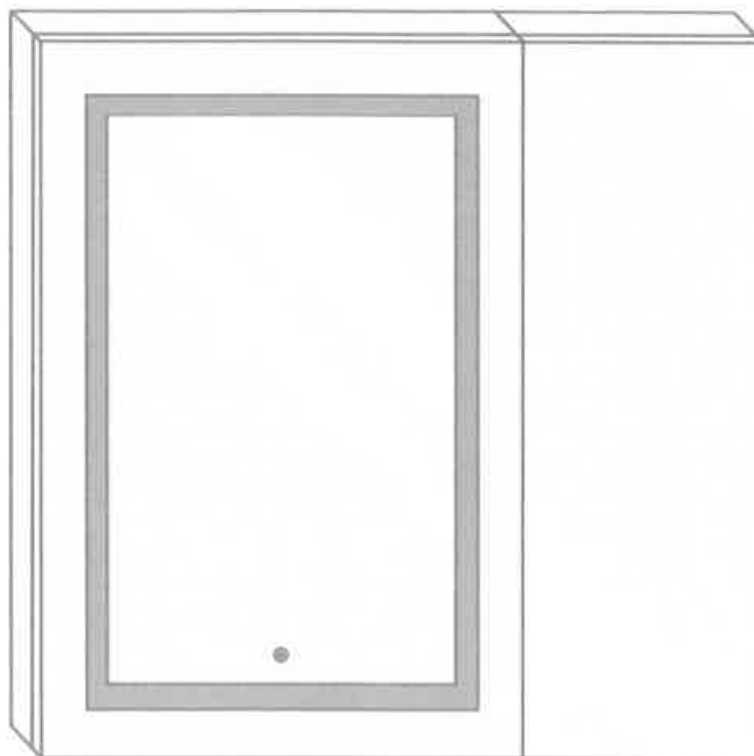

Features

- Dimmable LED task lighting
- Integrated touch sensor control with memory
- Energy efficient LED lighting 6000K
- 3100 Lumens
- CRI 90+
- Integrated Defogger

Construction

- Quality polished edge mirror
- Single phase wire installation
- 5 MM Silver Backed Copper Free
- Installation Either Surface Mount (Side Mirror Trim Panels included) or Recessed
- Includes installation hardware

Codes/Standards Applicable

- Conforms to UL Std. 962
- Cert. to CSA Std. C22.2 No.250.0-08
- ETL Intertek 5004931

Electrical System

- 120Vac, 60Hz, 53W
- Electric Current: 0.44A
- Wattage: 53W

Outlet

- Performance Requirements: Contains the required Supervisory Circuit with the Auto-Monitoring Function as noted by UL 1310
- Input Voltage: Min 112Vac, Norn 125Vac, Max 137Vac
- Frequency: 60Hz
- Front Receptacle Current: 102-132VAC Nominal 15A
- USB Output Current: SVDC Nominal 4A

Model

- SVANGE 2436L Left Swinging Door
- Included models in this configuration:
Cabinet 1 = 2436L Cabinet 2 = 1236L

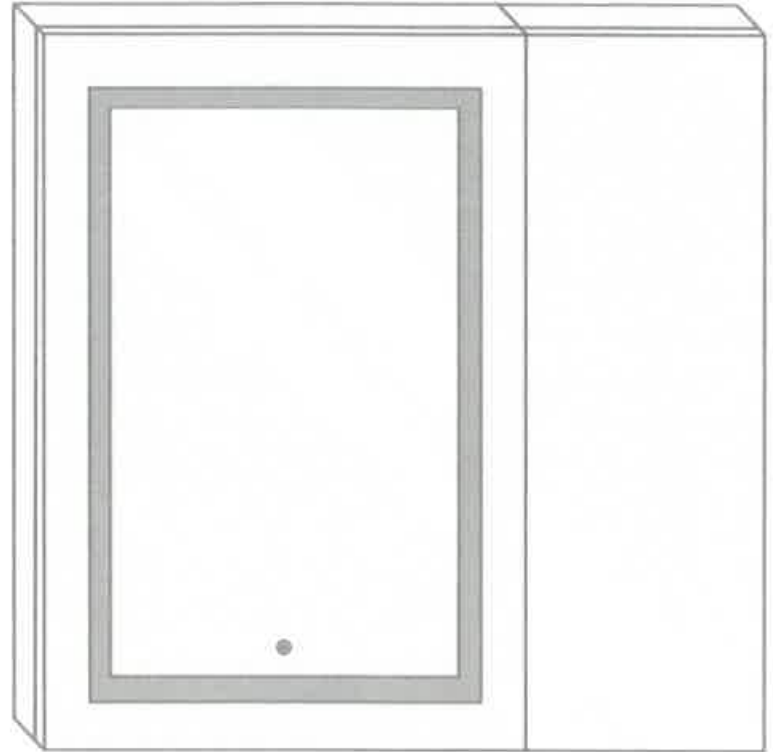

Cabinet Configuration

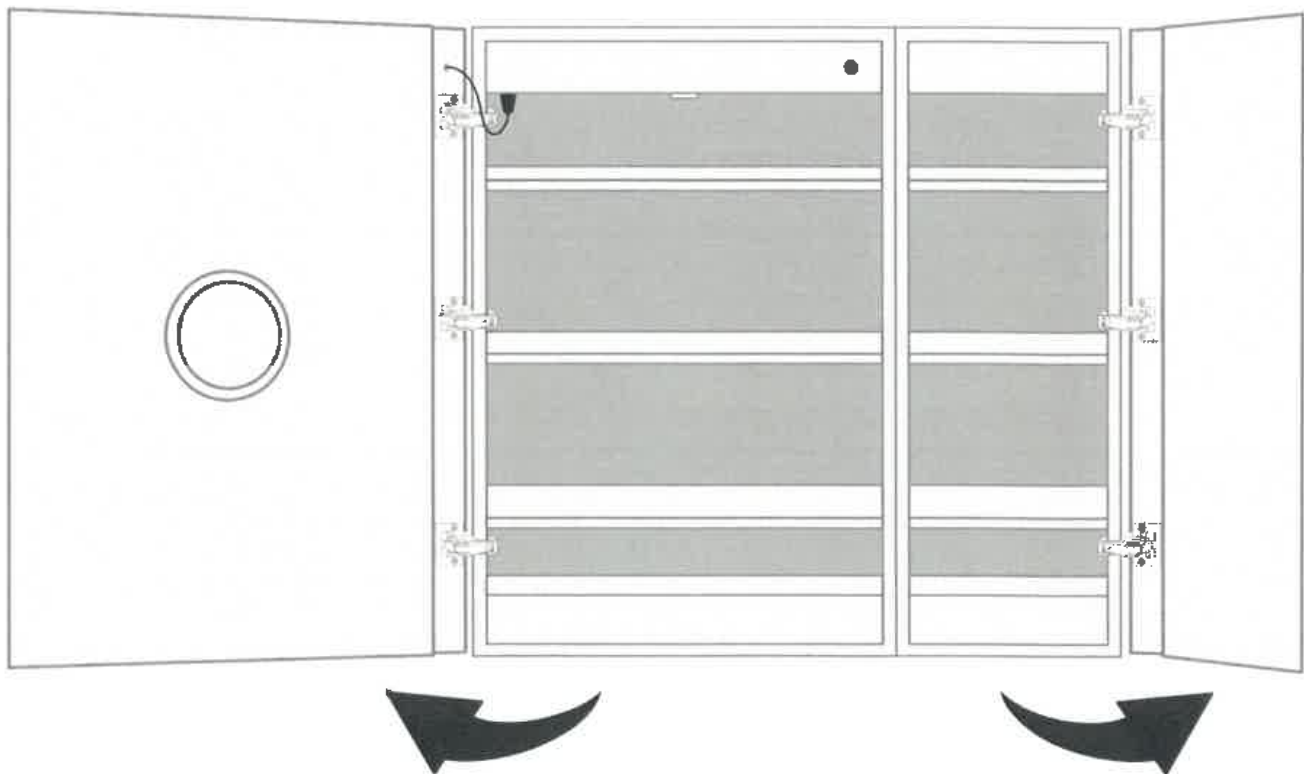
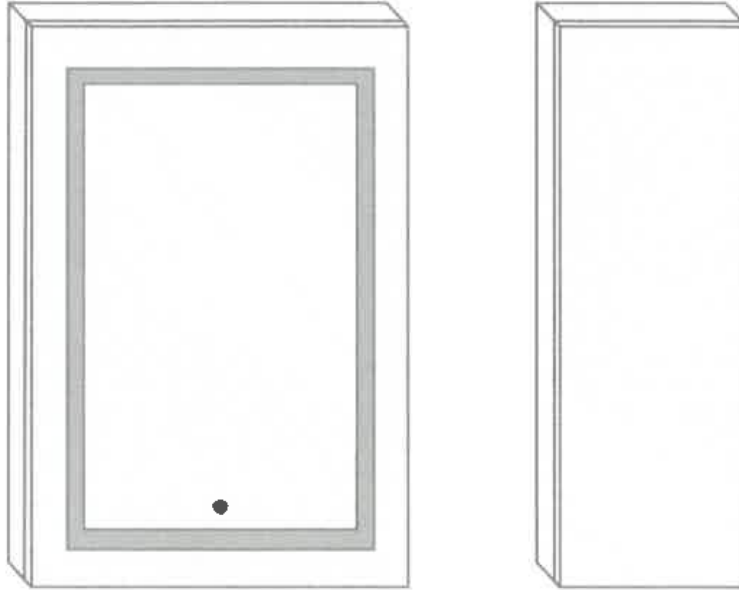

Included models in this configuration:
Cabinet 1 = 2436L Cabinet 2 = 1236L

STRASSER

SVANGE 3636L Medicine Cabinet

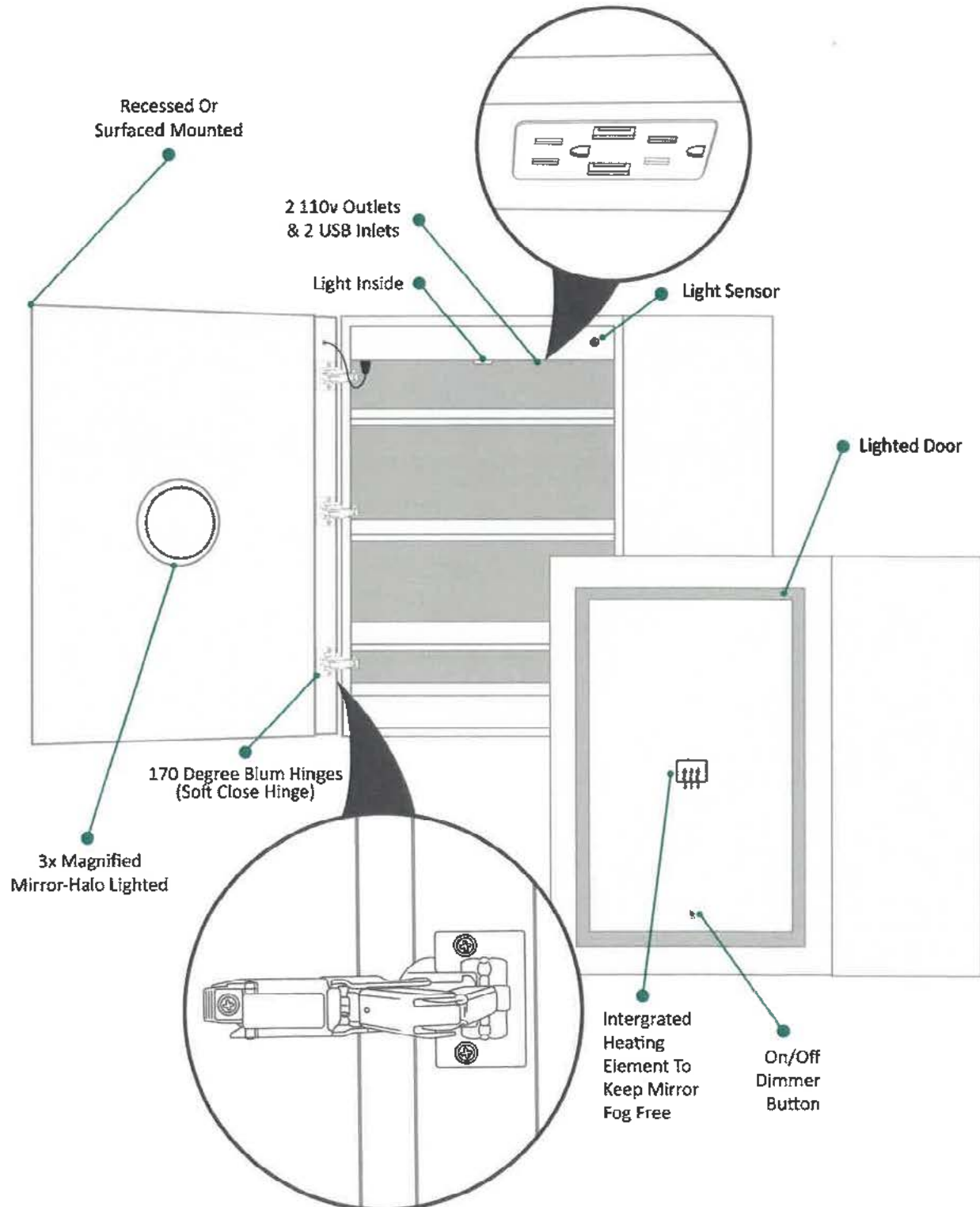

Surface Mount

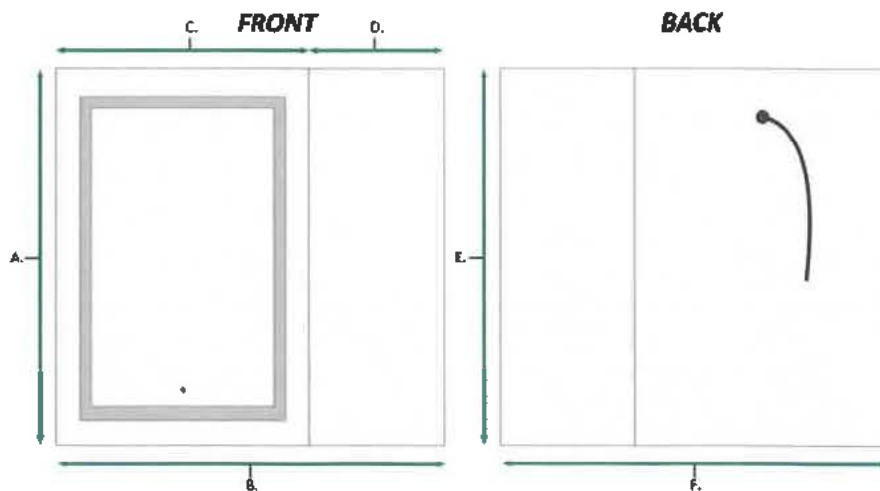
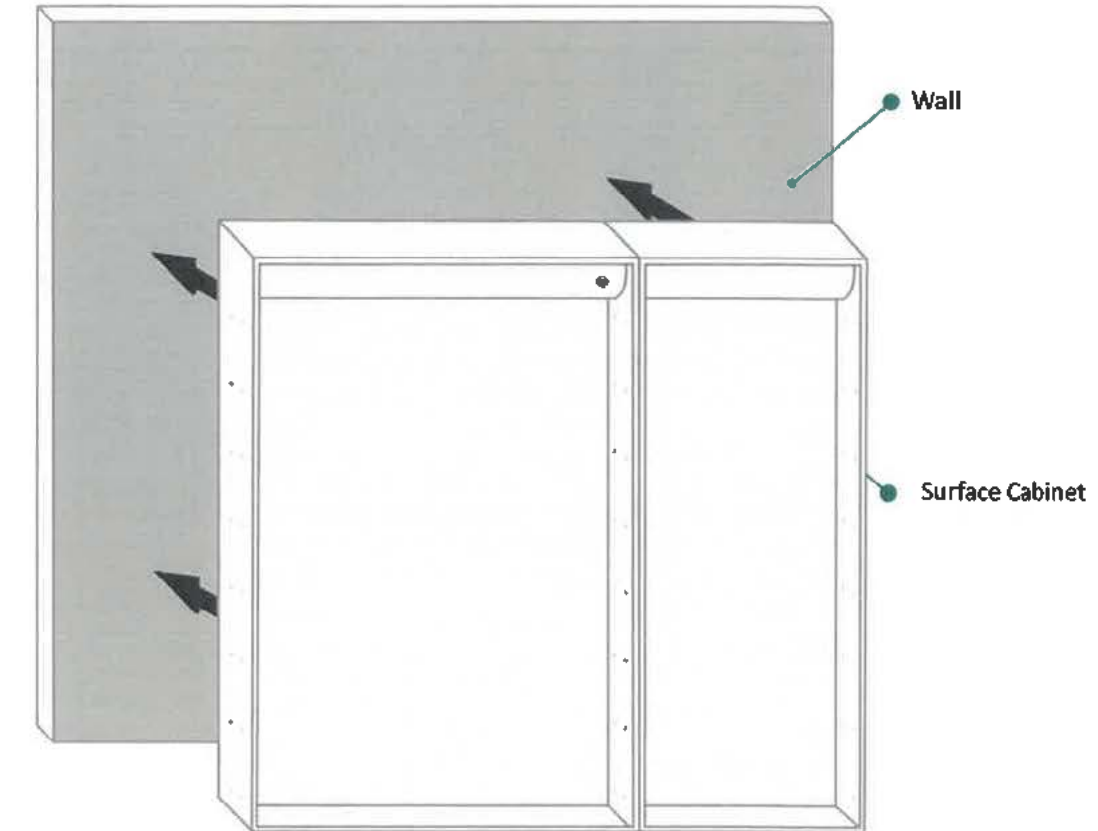

FRONT & BACKS

MODEL	A	B	C	D	E	F
SVANGE3636L	36	36-1/8	24	12	36	36-1/8

These measurements are for reference, for best results we suggest you measure actual product as small variations in size are possible.

Recessed Mount

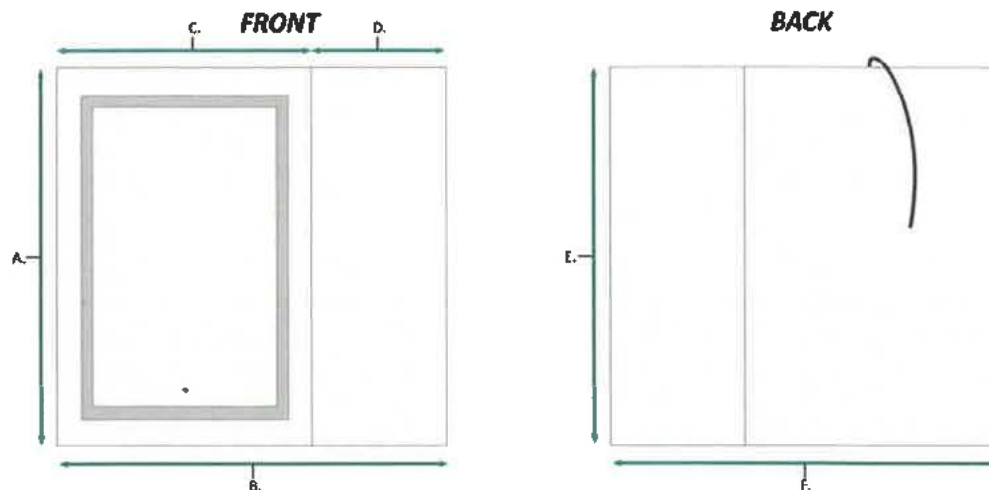
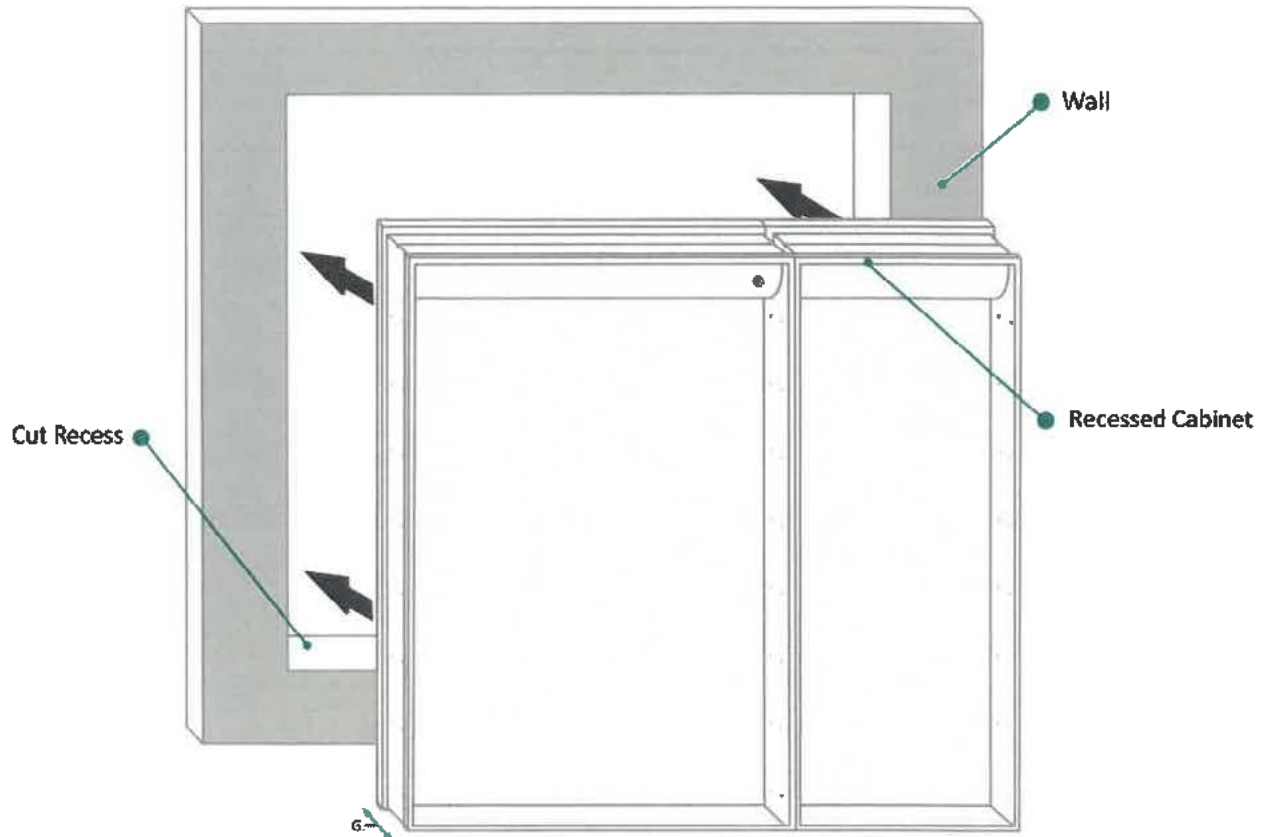

FRONT & BACK

MODEL	A	B	C	D	E	F	G
SVANGE3636L	36	36-1/8	24	12	35-1/8	35-1/8	3-1/2

These measurements are for reference, for best results we suggest you measure actual product as small variations in size are possible.

STRASSER

Specifications:
SVANGE 3636L
Medicine Cabinet

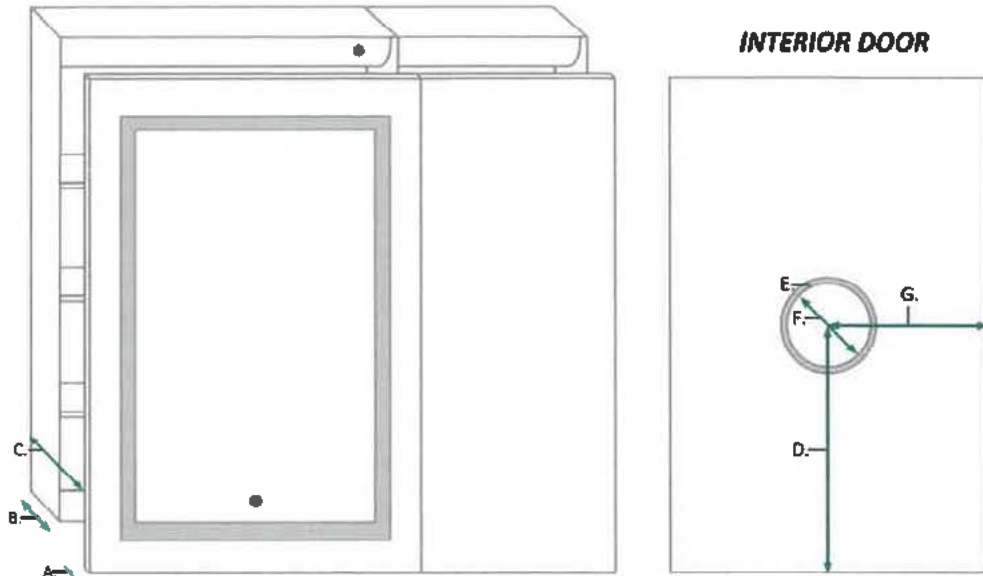

DOOR & CABINET

MODEL	A	B	C	D	E	F	G
SVANGE3636L	7/8	3-1/2	5	18	3-1/8	5-1/4	13

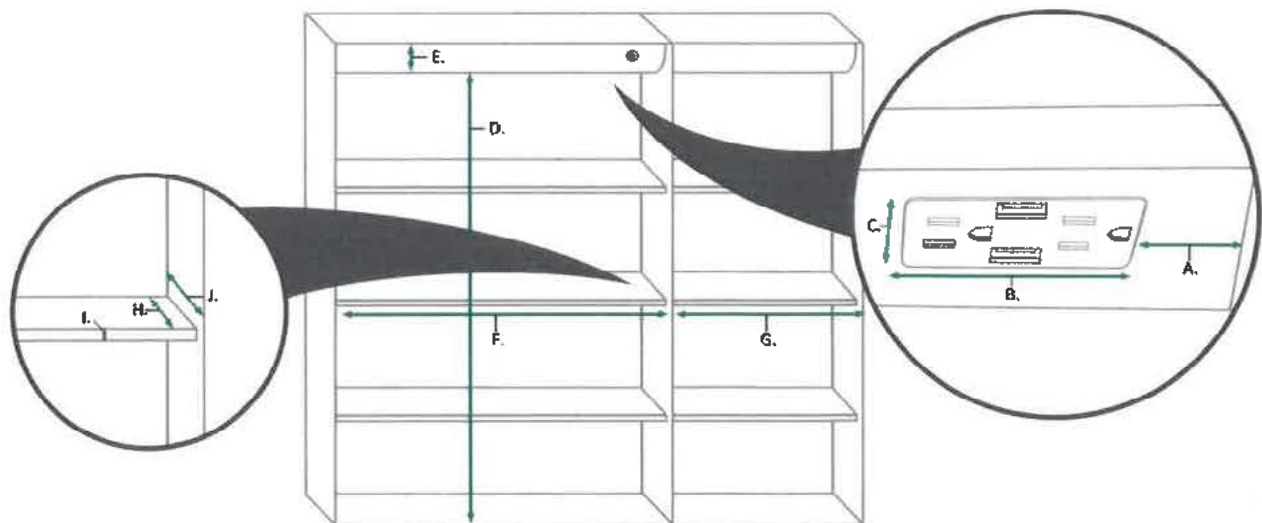

INTERIOR CABINET

MODEL	A	B	C	D	E	F	G	H	I	J
SVANGE3636L	3-3/4	5-5/8	1-1/4	32	2-1/4	22-1/4	10-1/4	2-3/8	3/8	3-5/8

These measurements are for reference, for best results we suggest you measure actual product as small variations in size are possible.